

## **HYGIENIC COUPLINGS**

### **Price list 2020**

	Page
General information	2
Combifit T-seals (ISO 2853, BS 4825 part 4)	3
Combifit Tri-Clamp seals (DIN 32676 (C), BS 4825 part 3)	4
Combifit Tri-Clamp seals (ISO 2852, DIN 32676 (A-B), BS 4825 part 3)	5
Combifit Flat-seals	6

Prices are ex works  
Prices are ex VAT

Platinastraat 20  
2718 RZ Zoetermeer  
The Netherlands

Phone +31 (0)79 3614929  
Mail [info@combifitBV.nl](mailto:info@combifitBV.nl)  
Website [www.combifitBV.nl](http://www.combifitBV.nl)

*In all cases in which we act as offeror or supplier, our offers, assignments given to us and agreements concluded with us are subject to the METAALUNIE TERMS AND CONDITIONS. These terms and conditions have been filed at the registry of the Rotterdam District Court. A copy is available.*



# GENERAL INFORMATION

The **Combifit T-seal** is a seal composed of a stainless steel outer ring having a T-shape profile and a rubber inner ring vulcanised onto the stainless steel outer ring. The **T-seal** is designed to obtain a hygienic seal in piping connections for food and pharmaceutical processes. These locations are traditional centres for bacteria cultures and regular disassembly often is the only way to clean the unit. Disassembly is expensive and interrupts the production process. Using the **Combifit T-seal** a full Cleaning In Place (C.I.P.) is possible.

If an article is not part of our standard program, please get in touch with COMBIFIT. We are probably able to manufacture according to your needs. Drawings and molds cost € 300,= per size and will be charged only once.

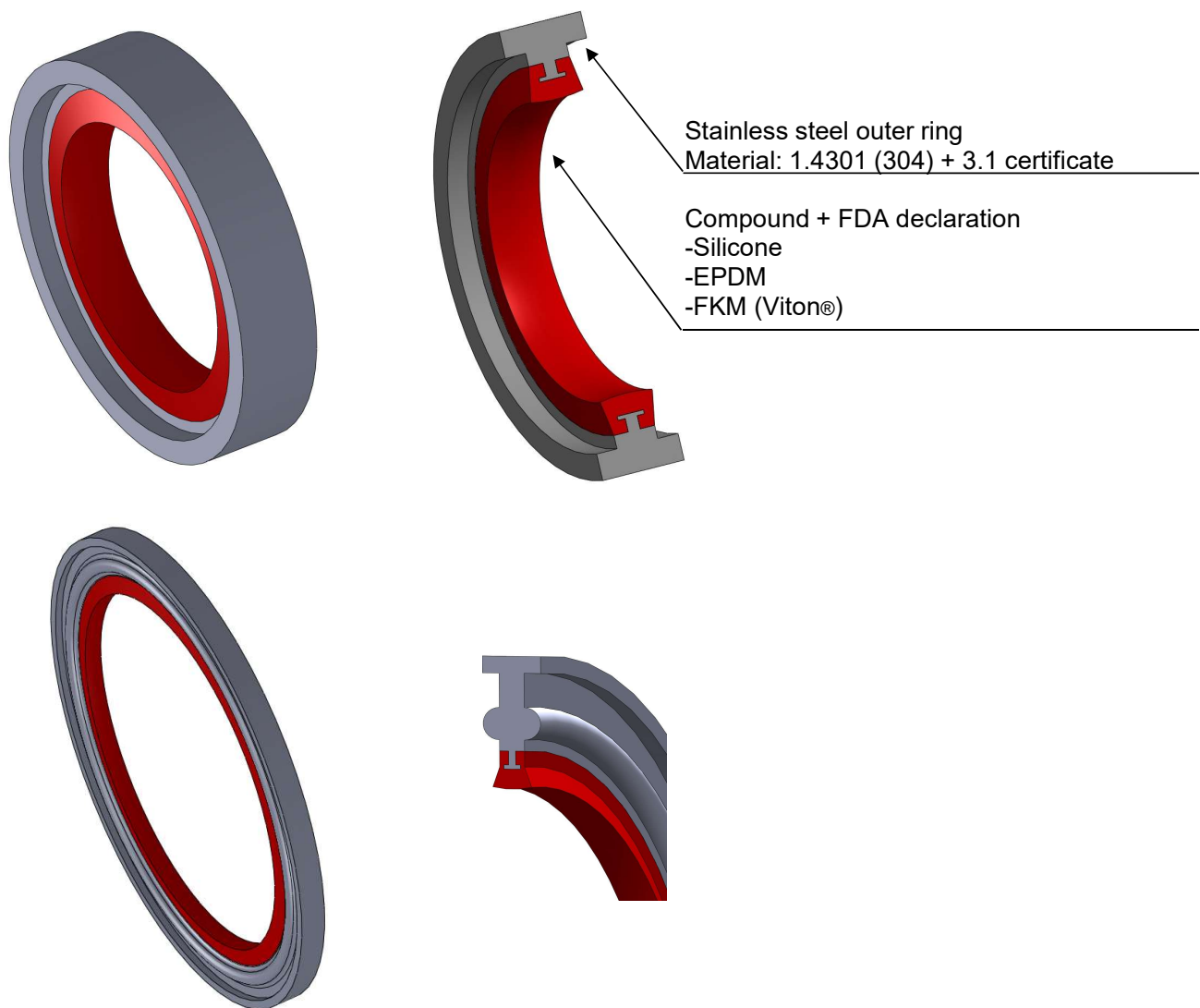

# COMBIFIT T-SEAL

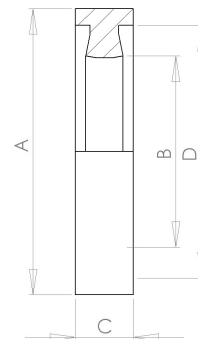
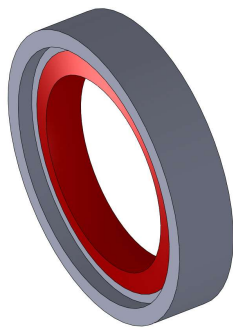

ISO 2853										
Combifit T-seal Material 1.4301	Size	A	B	C	D		Art. no.	gram	Silicone/ EPDM	FKM
	1"	33,7	22,6	6,8	30,0		VOE-1031	15	€ 18,62	€ 20,96
	1½"	47,2	35,6	6,8	43,0		VOE-1032	25	€ 20,18	€ 22,73
	2"	60,0	48,6	6,8	56,6		VOE-1033	31	€ 22,10	€ 24,92
	2½"	74,4	60,3	6,8	70,6		VOE-1034	42	€ 31,34	€ 35,41
	3"	87,0	72,9	6,8	83,0		VOE-1035	52	€ 36,89	€ 41,68
	4"	113,2	97,6	6,8	109,3		VOE-1036	76	€ 43,31	€ 48,98

Combifit T-seal Material 1.4301	Size	A	B	C			Art. no.	gram	Silicone/ EPDM	FKM
	DN15	29,0	16,0	6,8			DIN-1002	14	€ 24,61	€ 27,76
	DN20	33,5	20,0	6,8			DIN-1003	18	€ 24,61	€ 27,76
	DN25	40,0	26,0	6,8			DIN-1004	23	€ 26,70	€ 29,85
	DN32	46,0	32,0	6,8			DIN-1005	27	€ 26,70	€ 30,12
	DN40	52,0	38,0	6,8			DIN-1006	30	€ 29,28	€ 32,87
	DN50	60,0	49,0	6,8			VOE-1033	31	€ 29,28	€ 33,06
	DN65	80,0	66,0	6,8			DIN-1008	46	€ 49,14	€ 54,58
	DN80	95,0	81,0	6,8			DIN-1009	58	€ 53,78	€ 60,21
	DN100	114,0	100,0	6,8			DIN-1010	62	€ 57,70	€ 65,28

BS 4825 part 4										
Combifit T-seal Material 1.4301	Size	A	B	C	D		Art. no.	gram	Silicone/ EPDM	FKM
	1"	33,7	22,2	6,8	30,0		BS-1031	15	€ 18,62	€ 20,96
	1½"	47,2	34,9	6,8	43,0		BS-1032	25	€ 20,18	€ 22,73
	2"	60,0	47,6	6,8	56,6		BS-1033	31	€ 22,10	€ 24,92
	2½"	74,4	60,3	6,8	70,6		BS-1034	42	€ 31,34	€ 35,41
	3"	87,0	73,0	6,8	83,0		BS-1035	52	€ 36,89	€ 41,68
	4"	120,0	97,6	6,8	111,6		BS-1036	76	€ 43,31	€ 48,98

# COMBIFIT TRI-CLAMP SEAL

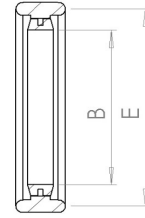
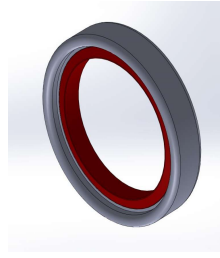
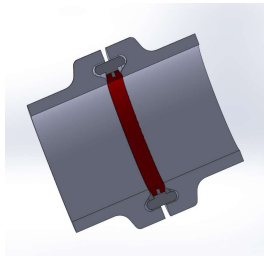

## DIN 32676 (C)

Combifit Tri-Clamp seal Material 1.4301	Size	A	B	C	D	E	Art. no.	gram	Silicone/ EPDM	FKM
	1/2"		9,50			20,2	DIN-2070	15	€ 28,73	€ 32,12

## BS 4825 part 3

Combifit Tri-Clamp seal Material 1.4301	Size	A	B	C	D	E	Art. no.	14	Silicone/ EPDM	FKM
	1/2"		9,50			20,3	BS-2029	15	€ 28,73	€ 32,12
	3/4"		15,85			20,3	BS-2030	18	€ 28,73	€ 32,12

# COMBIFIT TRI-CLAMP SEAL

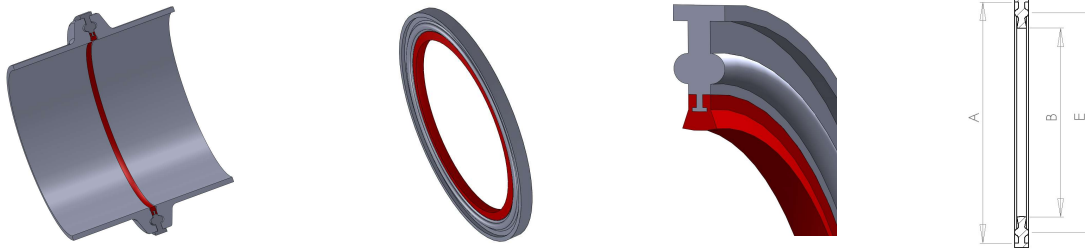

## ISO 2852

Combifit Tri-Clamp seal Material 1.4301	Size	A	B	C	D	E	Art. no.	gram	Silicone/ EPDM	FKM
	1"	50,5	22,6			43,5	VOE-2031	18	€ 29,88	€ 33,49
	1½"	50,5	35,6			43,5	VOE-2032	22	€ 29,88	€ 33,49
	2"	64,0	48,6			56,5	VOE-2033	31	€ 30,54	€ 34,50
	2½"	77,5	60,3			70,5	VOE-2034	40	€ 41,43	€ 46,41
	3"	91,0	72,9			83,5	VOE-2035	52	€ 51,25	€ 57,96
	4"	119,0	97,6			110,0	VOE-2036	76	€ 60,25	€ 68,16

## DIN 32676 (A)

Combifit Tri-Clamp seal Material 1.4301	Size	A	B	C	D	E	Art. no.	gram	Silicone/ EPDM	FKM
	DN10	34,0	10,0			27,5	DIN-2001	18	€ 21,79	€ 24,15
	DN15	34,0	16,0			27,5	DIN-2002	14	€ 21,79	€ 24,15
	DN20	34,0	20,0			27,5	DIN-2003	18	€ 21,79	€ 24,15
	DN25	50,5	26,0			43,5	DIN-2004	23	€ 27,83	€ 30,19
	DN32	50,5	32,0			43,5	DIN-2005	27	€ 27,83	€ 30,39
	DN40	50,5	38,0			43,5	DIN-2006	30	€ 27,83	€ 30,50
	DN50	64,0	50,0			56,5	DIN-2007	31	€ 30,54	€ 33,36
	DN65	91,0	66,0			83,5	DIN-2008	46	€ 51,25	€ 55,31
	DN80	106,0	81,0			97,0	DIN-2009	58	€ 57,60	€ 62,40
	DN100	119,0	100,0			110,0	DIN-2010	62	€ 60,25	€ 65,91

## DIN 32676 (B)

Combifit Tri-Clamp seal Material 1.4301	Size	A	B	C	D	E	Art. no.	gram	Silicone/ EPDM	FKM
	DN21,3	50,5	18,1			43,5	DIN-2054		€ 31,63	€ 35,20
	DN33,7	50,5	29,7			43,5	DIN-2056		€ 31,63	€ 35,20
	DN48,3	64,0	44,3			56,6	DIN-2058		€ 33,31	€ 36,20
	DN60,3	77,5	56,3			70,5	DIN-2059		€ 43,07	€ 48,01

## BS 4825 part 3

Combifit Tri-Clamp seal Material 1.4301	Size	A	B	C	D	E	Art. no.	gram	Silicone/ EPDM	FKM
	1"	50,5	22,20			43,5	BS-2031	20	€ 29,88	€ 33,49
	1½"	50,5	34,9			43,5	BS-2032	22	€ 29,88	€ 33,49
	2"	64,0	47,6			56,5	BS-2033	31	€ 30,54	€ 34,50
	2½"	77,5	60,3			70,5	BS-2034	40	€ 41,43	€ 46,41
	3"	91,0	73,0			83,5	BS-2035	52	€ 51,25	€ 57,96
	4"	119,0	97,6			110,0	BS-2036	76	€ 60,25	€ 68,16

# COMBIFIT FLAT SEAL

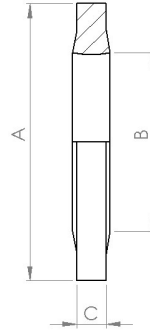
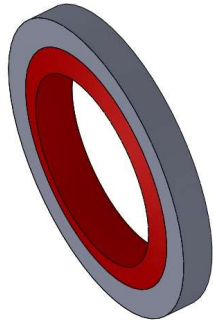

Combifit Flat seal Material 1.4301	Size	A	B	C			Art. no.	gram	Silicone/ EPDM	FKM
	1"	32,0	22,6	3,4			SCH-1001	4	€ 18,62	€ 20,96
	1,5"	45,0	35,6	3,4			SCH-1002	7	€ 20,18	€ 22,73
	2"	60,0	48,6	3,4			SCH-1003	10	€ 22,10	€ 24,92
	2½"	69,9	60,3	3,4			SCH-1004	10	€ 31,34	€ 35,41
	2¾"	75,0	66,0	3,4			SCH-1008	11	€ 47,82	€ 52,16
	3"	85,0	60,3	3,4			SCH-1005	17	€ 36,89	€ 41,68
	5"	130,0	108,0	3,4			SCH-1007	51	€ 100,12	€ 105,07
	DN65	79,8	66,3	3,4			SCH-1006	17	€ 68,43	€ 72,76